

INTERNATIONAL®
HX SERIES



INTERNATIONAL HX SERIES.





BRUTE FORCE MEETS SURGICAL PRECISION.

The International® HX® Series, now available with the International® S13 Integrated Powertrain.

Built to endure, thrive, and dominate any assignment, it's hard to imagine a truck with more capability than the International® HX® Series. But that's exactly what the engineers at International® Truck have done by adding the revolutionary International® S13 Integrated Powertrain as an option on the HX620. With its multiple factory-installed PTO options, easy serviceability, and precise low-speed maneuverability, the HX Series is engineered to raise the bar (and profits) at worksites everywhere.





SEVERE DUTY JOB? BRING IT.

The International® HX® Series has always been the go-to truck for the toughest applications. But it's also been the go-to truck for those who appreciate the finer things in life. Like best-in-class interior space, premium materials and a driver's seat designed to provide comfort and support load after load. Plus, thanks to features like built-in Diamond Logic® multiplex technology, and factory-installed lift axle options, the HX Series is a body company's dream.



IT ALL COMES TOGETHER

A clean sheet of paper and decades of experience. That's what the engineering team started with when they began work on the International® S13 Integrated Powertrain. And this wasn't just any team. This was a dream team of engineers located literally all over the world. Thanks to a spirit of collaboration between partner companies, the team was able to shift what's possible and rethink, redesign and reinvent what an integrated powertrain can be. The result is the S13 Engine, T14 Transmission, Dual Stage Aftertreatment system and nine PTO options – which, combined, make up the S13 Integrated Powertrain. A powertrain that delivers stellar performance, is easy to service and is at home on the toughest jobsites.

HIGH-PRESSURE FUEL SYSTEM

- ▶ Improved efficiency with less parasitic loss
- ▶ 1800 bar

9-BLADE FAN

- ▶ Converted from an 11-blade to a 9-blade for additional efficiency improvement

WATER PUMP

- ▶ Low displacement, low parasitic losses

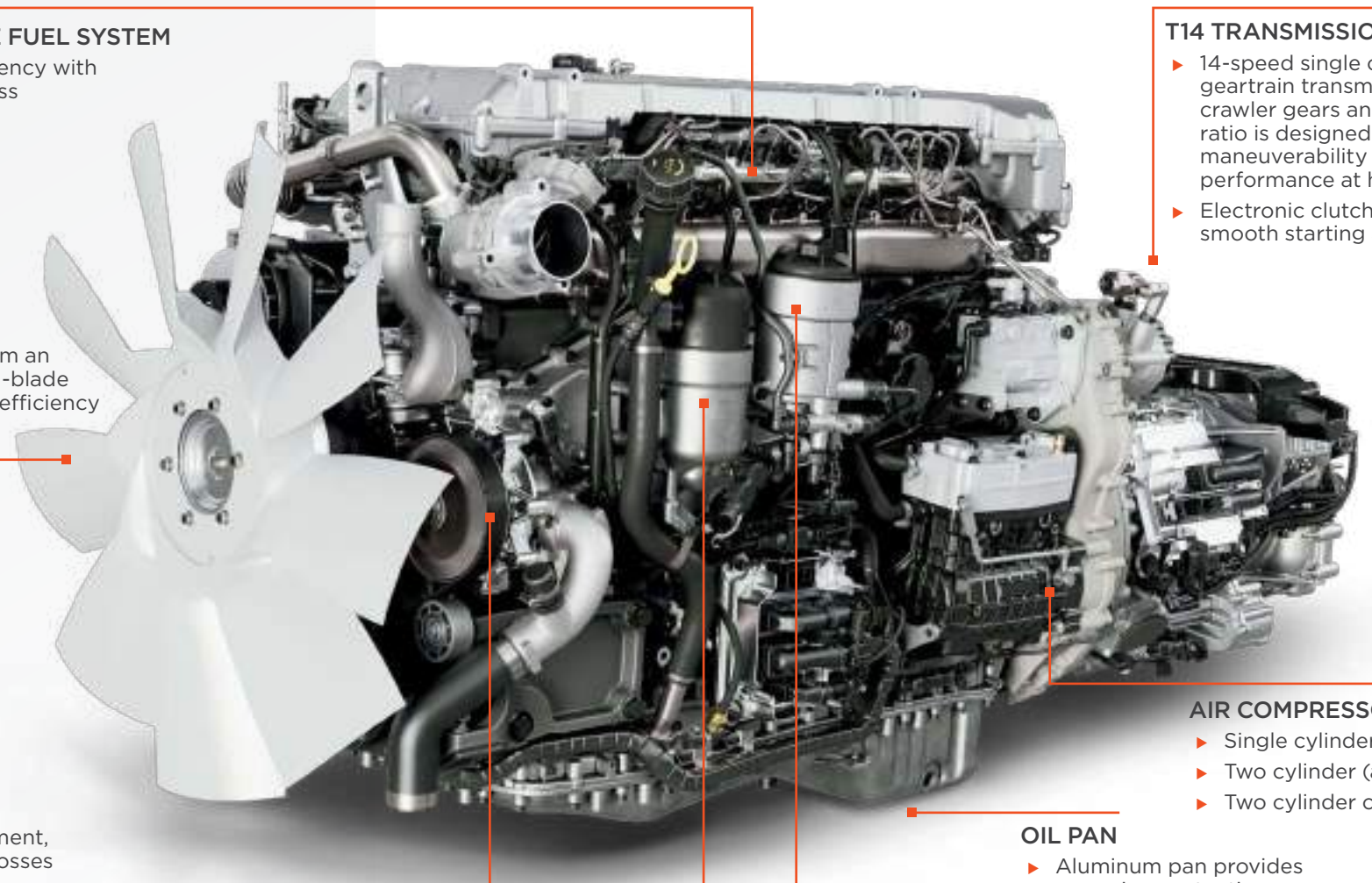

OIL FILTER

FUEL FILTER

- ▶ Offered with industry leading systems

T14 TRANSMISSION

- ▶ 14-speed single countershaft geartrain transmission with 2 crawler gears and a 26.7 overall ratio is designed for slow speed maneuverability as well as performance at highway speeds
- ▶ Electronic clutch actuator for smooth starting and fast shifting

AIR COMPRESSORS

- ▶ Single cylinder (iron)
- ▶ Two cylinder (aluminum)
- ▶ Two cylinder clutched (aluminum)

OIL PAN

- ▶ Aluminum pan provides corrosion protection

DUAL STAGE AFTERTREATMENT

- ▶ Compact design for more frame rail mounting space
- ▶ No active DPF regen
- ▶ No diesel oxidation catalyst

ELIMINATION OF EGR COOLER

- ▶ Improved reliability

ALUMINUM VALVE COVER

- ▶ Rugged and lightweight



FIXED GEOMETRY TURBO

- ▶ More reliable and efficient design

STANDARD INTEGRAL HEAT EXCHANGER AND OIL SYSTEM

- ▶ No horsepower or torque restrictions
- ▶ Variable oil system with dry sump in high range allows for reduced parasitic loss

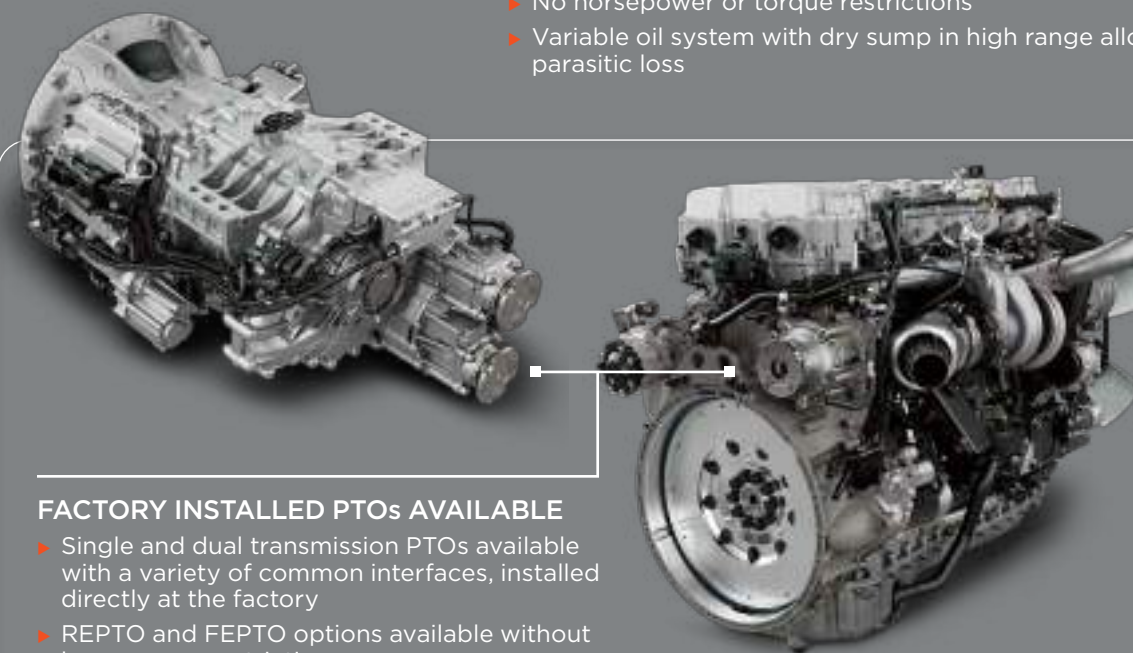

FACTORY INSTALLED PTOs AVAILABLE

- ▶ Single and dual transmission PTOs available with a variety of common interfaces, installed directly at the factory
- ▶ REPTO and FEPTO options available without horsepower restrictions

READY TO WORK: ON THE ROAD OR AT THE JOBSITE

The International® S13 Integrated Powertrain was designed with hard work in mind. The S13 delivers performance through its robust lightweight design, optimized gearing, and no active regens leading to more payloads delivered on the jobsite.

- Outstanding payload capacity
- Simple design, easy serviceability
- Exceptional fuel economy
- Nine PTO options including a dual option

Plus, thanks to the seamless integration of OnCommand® Connection Advanced Remote Diagnostics, the visibility into the health, location and performance of your assets has never been more accessible.



SHIFT WHAT'S POSSIBLE.

Any engine, no matter how well designed, is only as good as the transmission it's mated to. Delivering the power to the road in a smooth, predictable manner is no small feat when you consider the amount of torque of heavy-duty trucks. By starting with a clean sheet of paper, our engineers behind the S13 Integrated Powertrain were able to make sure the engine and transmission work in perfect harmony. The result is the fully automated T14 manual transmission with 14-speed overdrive. Its shifts are seamless and require no input from the driver in terms of being in the right gear at the right time.

VARIABLE OIL LEVEL UPPER RESERVOIR

- Oil is pumped to the reservoir under lower loads to reduce parasitic losses, allowing for the continuous lubrication of gears by the oil sprayers

PLANETARY GEARS

- The planetary gear set eliminates the need for a dedicated reverse gear, shortening the gearbox and allowing for better packaging within the chassis

SINGLE COUNTERSHAFT

- A single countershaft with helical gears lowers the overall weight of the unit without compromising the durability or performance of the transmission

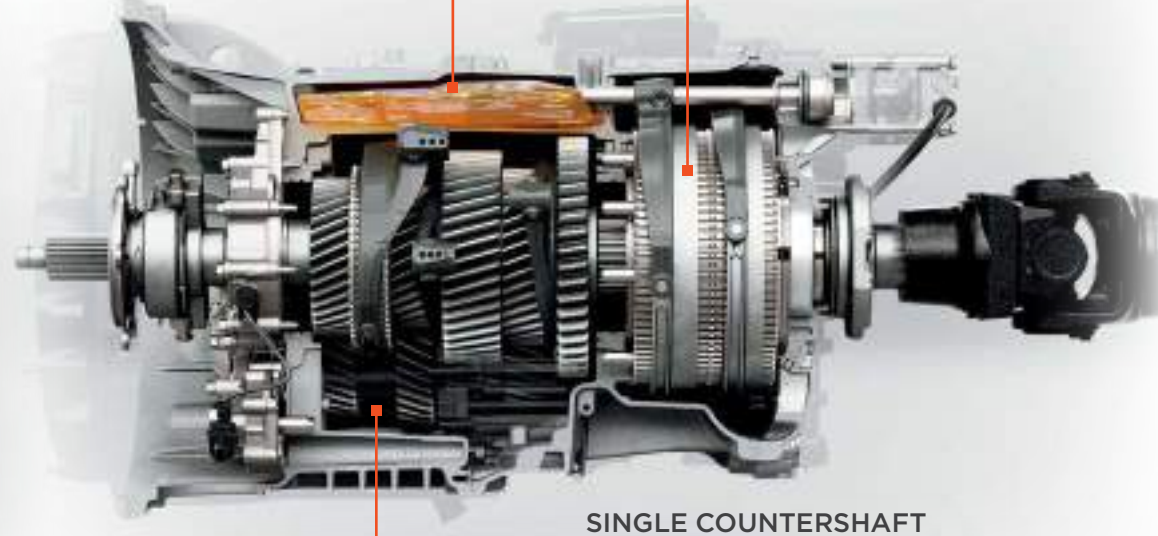

SHIFT ACTUATORS

- Shift actuator packaging was designed specifically for automated functionality (rather than adapted from a manual), allowing for more compact gearbox housing



THE TRANSMISSION CONTROL MODULE (TCM)

Features like predictive cruise control, neutral coast, downhill speed control, and predictive shifting, can now be found in one module — the TCM. Combining these features into one module means the vehicle feels more natural and intuitive and, ultimately, more efficient.

The transmission has an electronically controlled clutch actuator that works in sync with the engine to deliver faster, smoother shift performance. Since clutch engagement does not consume air during low speed maneuvers while navigating a tight job site, the drive never needs to stop and let the air recharge.



DOWNHILL SPEED CONTROL

Cruise control using the engine brake to slow down to a specific speed.

ROCKING MODE

Extracts a truck that has sunk into the ground by rocking it back and forth (without spinning the wheels) until it's free.

PAVER MODE

Enables the truck to be shifted from neutral into a forward gear without the driver needing to depress the brake. This helps ensure the smooth/uninterrupted delivery of material into the following asphalt paver.

DRIVE MODES

Three different shift modes for ultimate control for the driver

- ▶ Performance — Predictive shifting with fuel efficiency focus
- ▶ Performance+ — Perfect balance
- ▶ Off-road — Shifting at peak power with focus on performance



MANEUVERING MODE

Gives the driver more control of the vehicle in low speeds for specific movements such as navigating a tight construction site.

CREEP MODE

Allows the vehicle to automatically move both in drive and reverse when the brake pedal is released.





SIMPLIFIED MAINTENANCE MAXIMIZES UPTIME.

Keeping you on the road to profitability.

The faster your truck can be serviced, the faster you're back on the road, meeting delivery schedules and boosting your profitability.

The HX® Series is designed and engineered to optimize uptime. And when you do need service, you can count on expert technicians and an extensive parts inventory from your International® dealer.

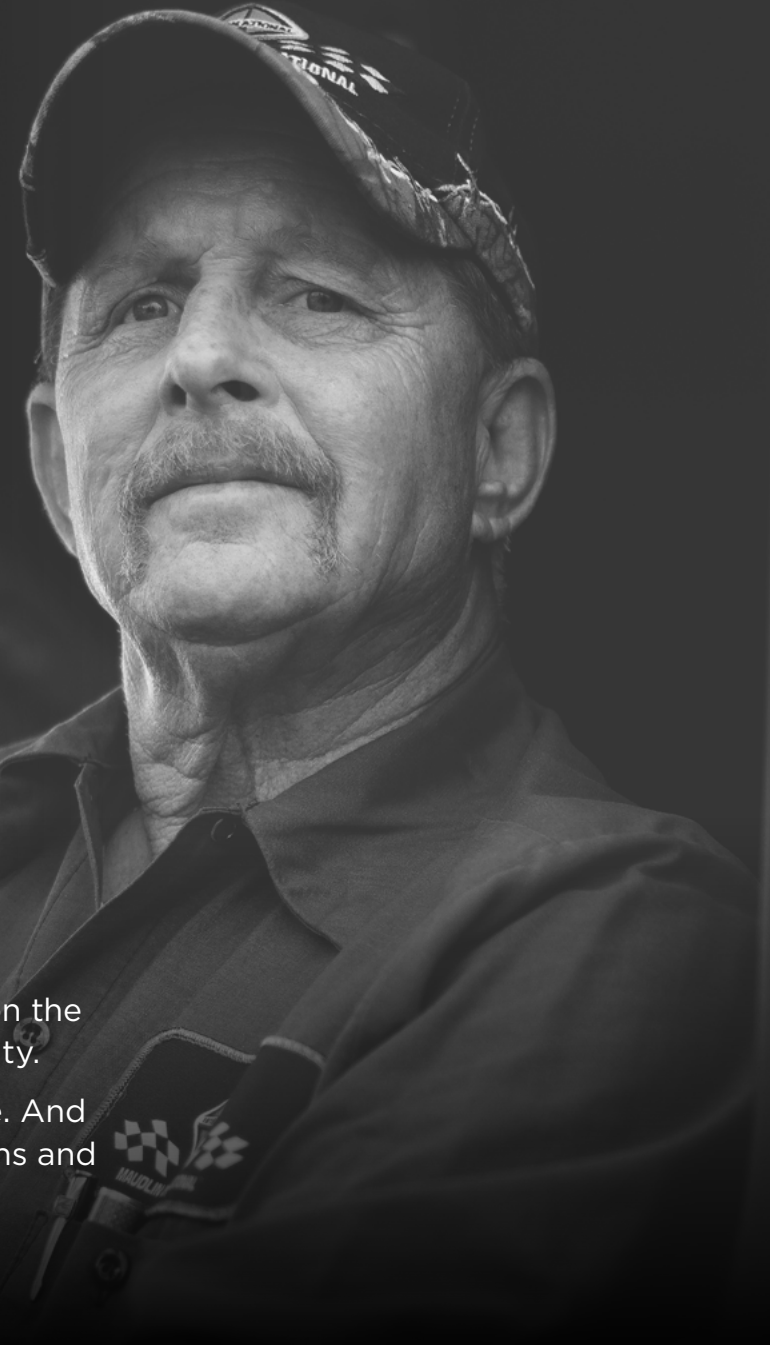

Simplified and optimized to keep you moving forward.

Every last part of the International® S13 Integrated Powertrain is engineered to be revolutionary, and its aftertreatment is no exception. It's built with a dual-stage SCR system—an advanced technology that removes the EGR cooler, diesel oxidation catalyst (DOC), and exhaust system fuel dosing—creating a system that doesn't require active regens.

KEY FEATURES

- ▶ Reduced engine soot for extended DPF service intervals
- ▶ Easy access to DPF for easy serviceability
- ▶ No diesel oxidation catalyst
- ▶ No fuel dosing
- ▶ 2 years unlimited miles, unlimited hours



Tethered caps on most fluid containers prevent dropped or lost caps while refreshing fluids.



Translucent containers allow you to check fluid levels at a glance.

UPTIME IS ABOUT THE DETAILS

- ▶ Driver controls and instrumentation are based on robust industry-standard SAE J1939 electrical architecture, with gauge cluster and switches designed to keep drivers focused and maximize uptime.
- ▶ Cab wiring features a power distribution module that's located inside the cab, protected from the elements.
- ▶ ChemGuard coating under the cab floor provides further corrosion protection.
- ▶ Models equipped with the International® A26 or the S13 Integrated Powertrain include over-the-air cellular programming for approved engine calibration and programmable parameters (Cummins® X15 includes engine calibration updates).





SOLUTIONS FOR WHATEVER YOUR BUSINESS NEEDS.



INTERNATIONAL® A26

**Lightweight, Quiet,
and Efficient Power**



The International® A26 engine offers premium performance in an advanced, fuel-efficient 12.4L design. The A26 produces up to 515 hp and 1,850 lb.-ft. of torque from a design with a best-in-class dry weight of 2,314 lbs. and is 600 to 700 lbs. lighter than traditional big bore engines. It also features North America's first Class 7-8 Compacted Graphite Iron (CGI) crankcase design.

Variable Geometry Turbocharger — Titanium compressor wheel provides excellent longevity. Serviceable electronic actuator increases uptime and reduces service cost.

Jacobs Engine Brake® — Variable Geometry Turbocharger improves engine braking performance, particularly at low-to-mid-RPMs and higher altitudes.

2500 Bar High-Pressure Common Rail Fuel System — Delivers maximum fuel injection pressure (36,300 psi) to reduce emissions and fuel consumption, with multiple injection events for smooth and quiet operation.

Lightweight design — Compacted Graphite Iron crankcase, shot-peened aluminum flywheel housing, composite valve covers, and a hollow camshaft deliver a lightweight design, maximizing payload capacity.

Cold starting — Cold starting down to -40°F with available oil heater, coolant heater, and cold start system with unaided cold starting down to 10°F for dependable starting in extreme climates or when plug-in heating isn't available.



CUMMINS® X15

**Proven Muscle
for the Long Haul**

The X15 Efficiency Series produces up to 500 hp with advanced fuel-saving technology that includes dynamic electronic controls with ADEPT features, enhanced engine breathing and an optimized combustion process that leverages Cummins' proprietary VGT™ Turbo and XPI fuel system.

VGT Turbocharger — Featuring a patented sliding nozzle ring, the VGT Turbocharger used on Cummins X15 engines offers higher boost pressures at low engine speeds.

XPI Fuel System — High pressure enables multiple injection events per cycle for industry-leading fuel economy and quieter operation. With a standard thermal recirculation valve, the X15 is prepared to handle even the most challenging weather conditions.

Single-Module™ Aftertreatment System — Compact and lightweight, the Single-Module Aftertreatment provides better heat management and retention, delivering improved fuel economy compared to previous aftertreatment systems.





BUILT AROUND YOU.

The business-end of any truck is actually behind the steering wheel.

It's the drivers that complete the job and we made sure it's the drivers who get rewarded with our available Diamond Elite interior featuring top-of-the-line materials and equipment like premium Isringhausen seats for best-in-

class comfort. Engineered for productivity, the HX[®] Series includes a programmable digital gauge cluster so drivers can keep the information they want front and center - including the status of the lift axles.

The premium gauge cluster includes a customizable digital display which provides a wealth of information for the driver, including:

- ▶ Real-time fuel economy
- ▶ Axle load*
- ▶ Custom gauge settings*
- ▶ Safety indicators*
- ▶ Digital speedometer
- ▶ Tire pressure*

The color, illumination, legibility and even the type font and size of gauges is designed to deliver optimal viewing in varying light conditions, maximizing alertness and minimizing eye fatigue.



*When added with optional feature code for required sensors



RULE #1: ALWAYS TAKE CARE OF THE DRIVER.



SEAT OF POWER



A premium truck demands a premium cab. And just as there's no truck that can out-work the HX® Series, nobody offers a more comfortable interior. The new Diamond Elite trim level provides best-in-class comfort – providing the ideal temperature, support and seating position for the most discerning drivers.

A well-designed seat should help the driver stay fresh and alert. That's why the Diamond Elite seat in the HX® Series has so many adjustments. It can be now be tailored to suit drivers of all shapes and sizes, incorporating features normally only found in luxury automobiles.

Seat cushion adjustment

- ▶ Controls the bottom seat cushion length and tilt
- ▶ Helps accommodate drivers of all heights by distributing leg support

Fore/Aft Isolator & Adjustable Shock Absorber

- ▶ Sometimes known as a “chugger,” the fore / aft Isolator dampens the movement/jostling caused by various loads
- ▶ The Adjustable Shock Absorber can vary the stiffness of the ride to match the road profile

Seat Length and Height Adjustment

- ▶ The height and length adjustment allows drivers to find the perfect driving position
- ▶ Pneumatic Lumbar and Side Bolster Supports
- ▶ The 2-chamber lumbar adjustment is especially appreciated by drivers who spend long hours behind the wheel
- ▶ Pneumatic side bolsters provide additional upper body support and helps the the driver sit more upright

Seat Backrest and Armrest

- ▶ The adjustable backrest provides up to 52 degrees of range
- ▶ The armrest is designed to provide support for drivers of various sizes

Seat Climate Control

- ▶ Active seat ventilation helps keep drivers and passengers comfortable on a long drive in any weather
- ▶ Two fans draw fresh cabin air into the seats allowing the air to circulate and keeping perspiration to a minimum
- ▶ A sensor is located in both the seat and backrest to ensure uniform temperature distribution



“Every little creature comfort you can get to help make the operation of the truck easier, it's a big deal for the driver.”

- Group Ready Mix Manager Justin Tucker



**WORK HARD.
REST EASY.**



Nothing feels better after a hard day's work than a solid night's rest. The optional HX® Series sleeper cab provides drivers with a comfortable and spacious home where they can kick back, relax, and catch some z's. Because when dawn breaks, they need to be ready to get back to work — just like always.

HX SERIES SLEEPER CAB FEATURES

- ▶ Control panel located at head of bunk for blower speed, temperature controls, winter/summer selector switch, roof light switch, radio volume and balance controls, 12-volt power source
- ▶ Available insulated sleeper compartment curtain
- ▶ Two exterior lockers for access to luggage within the sleeper
- ▶ Available inner spring mattress for lower bunk
- ▶ Available windshield curtain for privacy

SLEEPER FEATURES

- 12 Volt Power Supply
- Trim Panels
- Headliner
- Sleeper Windows
- Windshield Curtain
- Sleeper Control Panel
- Microwave Accommodation
- TV Accommodation

DIAMOND ELITE

- Standard
- Easy To Clean Soft Vinyl Trim With Satin Mahogany Inserts
- Soft Vinyl
- Standard
- Optional
- Standard
- Optional
- Optional

56" Low Roof Sleeper Features

- Overhead Storage: Two Airline Style Cabinets Standard, with an Option for Two Additional

56" Hi-Rise Sleeper Features

- Overhead Storage: Two Compartments with Netting or Doors
- Rear Wall Storage: Optional

73" Hi-Rise Sleeper Features

- Overhead Storage: Optional Two or Four Compartments with Nets or Optional Doors
- Rear Wall Storage: Optional
- Driver Side Wardrobe: Standard, Optional Doors
- Passenger Side Cabinets: Utility Cabinet, Lower Right Wardrobe Tower Cabinet, Dresser Cabinet, Refrigerator Storage With or Without Doors



CHROME FOR DAYS, NIGHTS, WEEKENDS AND OVERTIME.



The International® HX® Series is not only a tool for business, but also a calling card. Seen frequently with some of the more elaborate paintjobs on the road, this 45-ton rolling billboard is the perfect way to spread the word. Plus, with available chrome external air cleaners along with chrome pedestal mirrors, grille surround and bumper, the HX Series is already hard to miss.

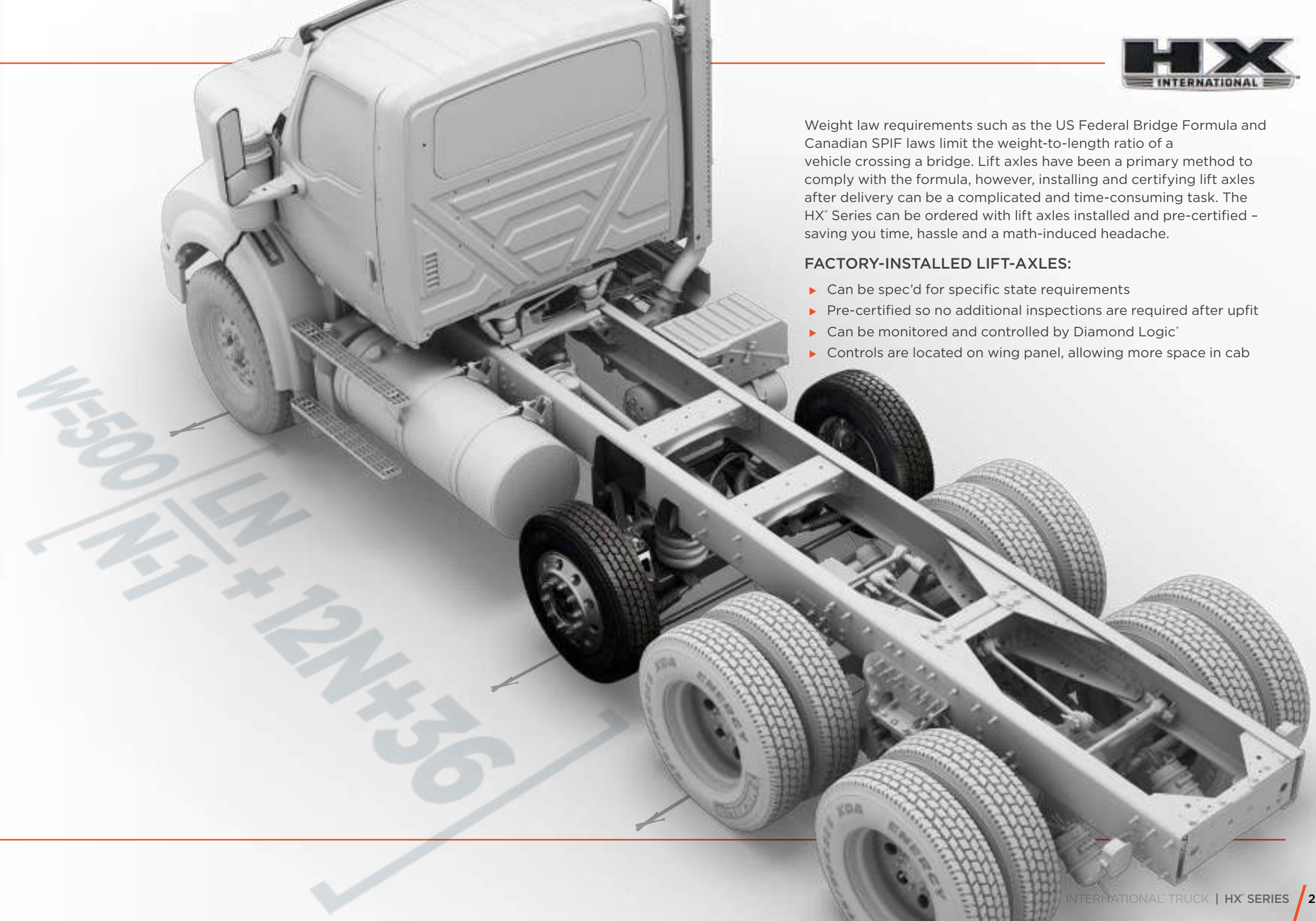

Weight law requirements such as the US Federal Bridge Formula and Canadian SPIF laws limit the weight-to-length ratio of a vehicle crossing a bridge. Lift axles have been a primary method to comply with the formula, however, installing and certifying lift axles after delivery can be a complicated and time-consuming task. The HX® Series can be ordered with lift axles installed and pre-certified – saving you time, hassle and a math-induced headache.

FACTORY-INSTALLED LIFT-AXLES:

- ▶ Can be spec'd for specific state requirements
- ▶ Pre-certified so no additional inspections are required after upfit
- ▶ Can be monitored and controlled by Diamond Logic®
- ▶ Controls are located on wing panel, allowing more space in cab

READY TO RUMBLE.

The International® HX® Series is available with a dynamic range of factory-installed lift axles, pre-certified and ready to get to work. Spacing accommodations can be made for various bridge laws and the controls for the lift axle are integrated into the wing panel through Diamond Logic® – freeing up the space between the front seats for other important items.



CAB OF STEEL.

Extreme Duty Cab

The cab of the International® HX® Series is made of tough, durable, high-strength steel that's easy to repair. New advancements in manufacturing means that steel can now offer practically the same corrosion resistance as aluminum without a significant weight penalty – not to mention greater strength.

CHEMGUARD COATING

This inter-reactive, chrome-zinc phosphate coating is applied on top of the galvanized steel. Its self-healing properties allow the surface to be scratched, cut or perforated and still maintain corrosion protection.

REINFORCED B-PILLARS

For extra cab strength and to support the new cab-mounted exhaust option, every HX Series includes reinforced B-Pillars.

OPTIONAL SPRAY-ON LINER COATING FLOOR PROTECTION

This polyurethane and polyurea formulation has earned industry respect for its durable, long-lasting and high-performance qualities. Designed to protect against abrasion, corrosion and impact, this OEM-grade coating can be found on over 4 million pickup bedliners.



A No-Compromise Anti-Corrosion Approach

To provide the strength and easy-to-repair qualities of steel with the corrosion resistance severe-duty customers demand, the Extreme Duty cab of the HX® Series features a special paint and coating process designed with endurance in mind.

Corrosion Protection Process:

Corrosion Protection Process:

1. Stamped steel with 60G/60G dual sided galvanized coating - standard on dash and toe and floor panels
2. Custom-engineered caustic and surfactant formula cleans and preps the steel
3. Proprietary tri-metal (nickel, zinc, manganese) phosphate blend provides robust corrosion protection and the first level of paint adhesion
4. Epoxy-based electrodeposition primer, or E-Coat is applied. This covers and seals the entire exposed metal surface of the cab
5. Acrylic basecoat
6. Urethane clearcoat

E-Coat Paint Process

CLEARCOAT

BASECOAT

E-COAT

GALVANIZED STEEL

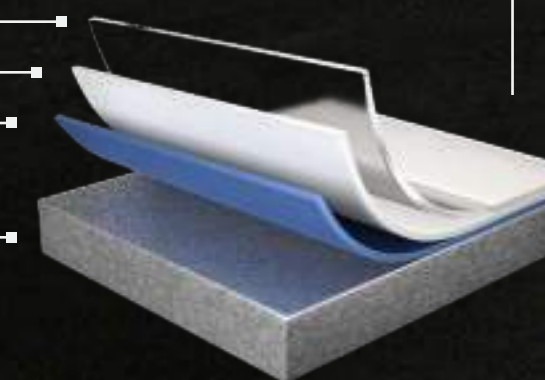

STRUCTURAL ENHANCEMENTS

Through extensive CAD modeling and rigorous testing, International engineers were able to design a cab with exceptional structural toughness.

STRUT BRACE (sleeper only)

- ▶ A strut brace improves dash endurance.



SLED RUNNERS (day cab and sleeper)

- ▶ The HX® Series cab variants feature high strength steel sled runners for improved durability





AS COMFORTABLE ON THE SITE AS YOU ARE GETTING THERE.



25 MINUTES

DEFROST LIKE NOBODY'S BUSINESS.

The quicker you can see, the quicker you can get to work. Based on internal testing, the entire windshield can be cleared within 25 minutes.

WORKSITE DURABILITY.

The worksite can be a rough place and very few vehicles leave without some kind of battle wound. But if the truck is made out of the right materials, the repair can be relatively painless. Compared to aluminum, repairing steel body panels like those found on the HX[®] Series is a piece of cake. Plus, the DCPD (Dicyclopentadiene) three-piece hood is stronger than fiberglass and resists cracking over the life of the truck.

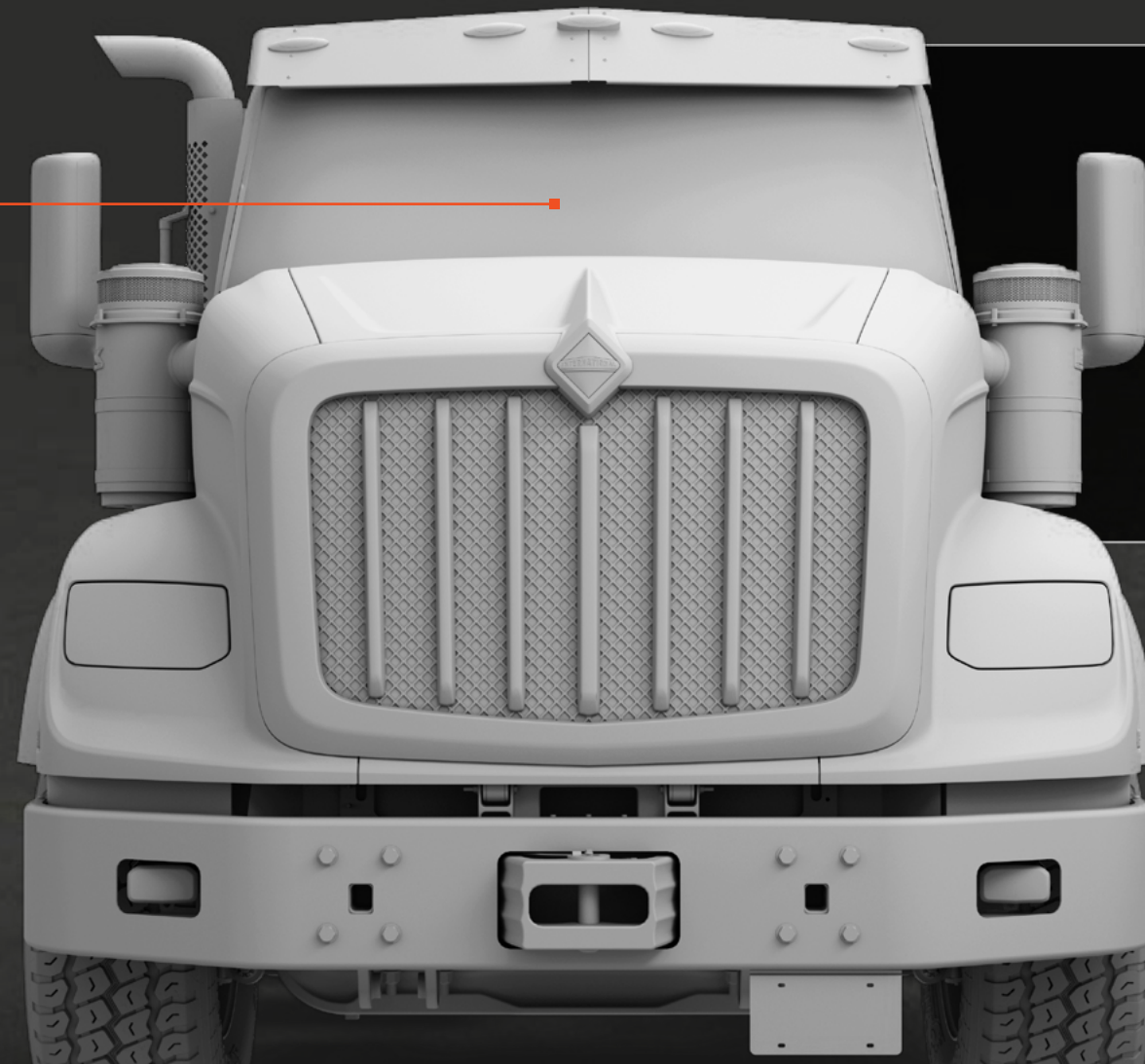

Getting to the worksite is only half the job. Being productive at the worksite is what pays the bills. The HX[®] Series makes this task as easy as possible by providing industry-leading HVAC, expansive driver sight lines and impressive, obstacle-avoiding maneuverability - not to mention its spacious and accommodating cab - a cab you can work in all day long without feeling cramped.

ROOM TO APPRECIATE.

The scalloped shape of the door panels offers ample hip and elbow room while also providing a comfortable place to rest your arm. The full-grip interior handle provides excellent leverage to open and close the doors and the door pockets offer convenient access to maps or paperwork.

EASIER SLEEPER ACCESS.

The cab design allows for excellent driver pivot access and legroom. Plus the design of the lower console makes it easy to turn in for the night.

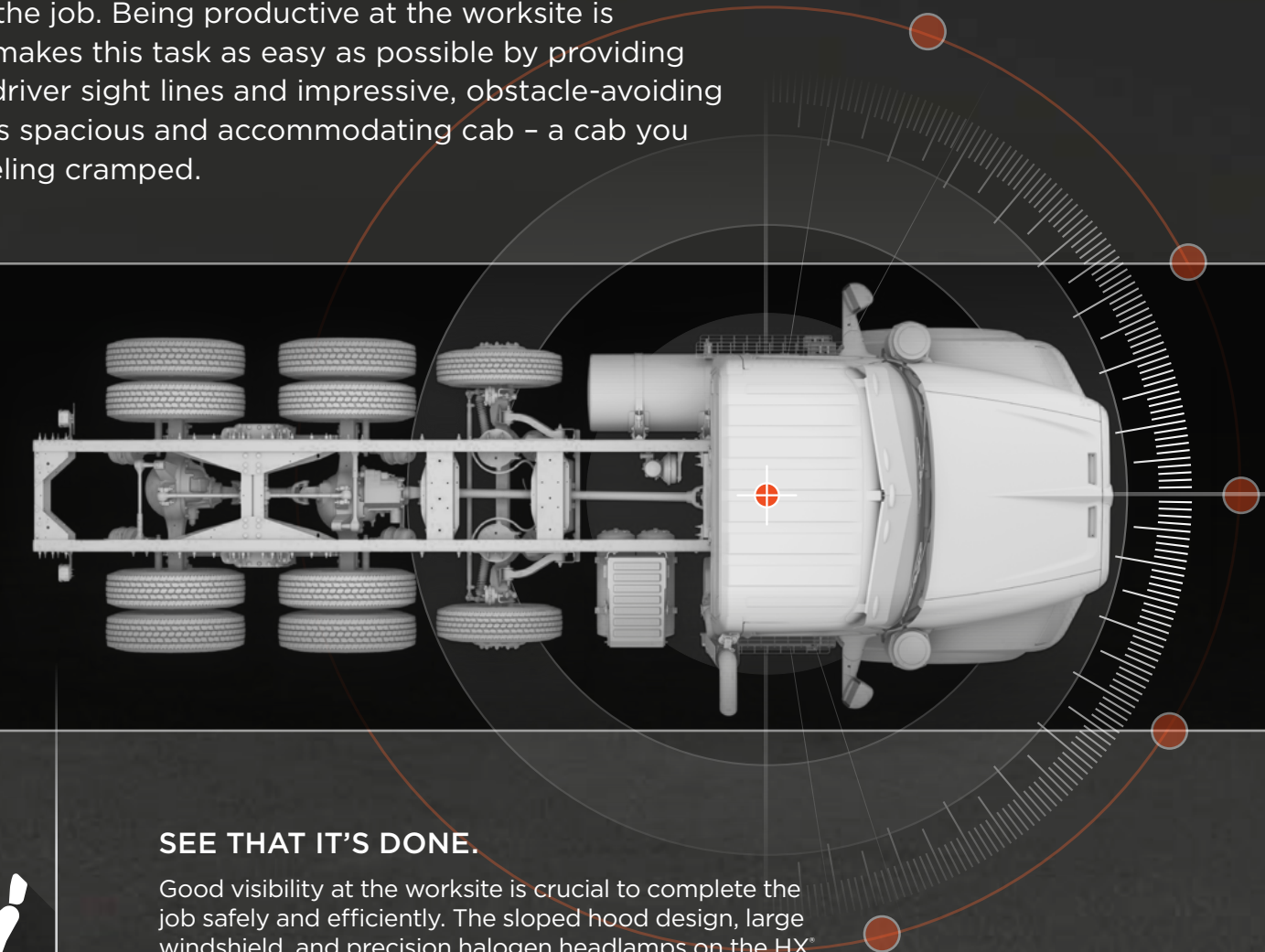

SEE THAT IT'S DONE.

Good visibility at the worksite is crucial to complete the job safely and efficiently. The sloped hood design, large windshield, and precision halogen headlamps on the HX[®] Series all contribute to provide outstanding visibility.



A TEM-READY TASK MASTER.

The Diamond Logic® Electrical System, standard on the International® HX® Series, allows you to customize the vehicle chassis, enabling control of vehicle components and body equipment.

Combined with the clean CA frame rails, factory-installed lift axles and various moveable components, the HX® Series allows TEMS to create the ideal solution for your application requirements.



Body Company Benefits—Mixer:

- ▶ Specific cross-member location to accommodate mixer PTO pump
- ▶ Factory-installed transition brackets for body mounting
- ▶ Inverted after-frame cross members for booster axle ram clearance

Body Company Benefits—Crane:

- ▶ Customized frame ladder and component locations to meet body packaging requirements
- ▶ Available integral front frame extensions
- ▶ Single 1/2", 3.5 million RBM straight frame rail provides high strength for high capacity crane applications

Body Company Benefits—Dump:

- ▶ Single 1/2", 3.5 million RBM straight frame rail provides high strength without added weight or risk of corrosion
- ▶ Factory installed lift axles with many customizable chassis packaging options
- ▶ Available in-cab battery box provides increased chassis packaging flexibility

INTERNATIONAL TRUCK SPECIALTY CENTERS

Your quick, efficient and cost-effective upfitting solution. Count on:

- ▶ Quality modifications covered under manufacturer's warranty
- ▶ Upfit process supervised by International engineers to ensure factory production-level quality
- ▶ Expertise to identify and resolve problems quickly
- ▶ A quick and efficient process ensured by optimized delivery cycle times and comprehensive factory support



DIAMOND PARTNER

LINKING TEMS WITH DEALERS TO STREAMLINE INSTALLATIONS AND ENHANCE CUSTOMER UPTIME

The Diamond Partner Program creates a new conduit between International Truck, our dealers and TEMs by providing industry-leading body-builder support materials and services. Through the program, it's now easier than ever for TEMs to mount their equipment faster, with a higher build quality and lower costs. In addition, the program facilitates joint marketing opportunities that can help increase awareness of the dealer and TEM partners.



THE ADVANCED DIAMOND LOGIC[®] ELECTRICAL SYSTEM.

Make complicated applications safer, more seamless and easier-to-use.

The International[®] Truck electrical system is a multiplexed, Diamond Logic[®] capable system that is considered the most advanced in the industry—and for good reason.

Diamond Logic streamlines chassis and body equipment integration and allows customers to choose from nearly 200 pre-programmed tasks. Customers can also develop their own with the help of a technician (over 260 International technicians are certified Level 3 – the highest certification) or completely on their own using Diamond Logic Builder software. The result is more consistent integrations, improved performance, increased equipment protection and crew safety.



DIAMOND LOGIC BUILDER

Have a specific application requirement? International can train and certify your technicians on Diamond Logic Builder so you can write your own custom logic as you go.

SAFETY FIRST

Diamond Logic opens up a world possibilities when it comes to safety.

- ▶ **Safety for the Driver:** Various functions including pre-trip inspections, interlocks, auto work lights, and equipment status lights can be programmed to help ensure driver safety and assist in protecting your vehicle
- ▶ **Safety on the Jobsite:** Interlocks for boom hydraulics, outriggers and PTO can increase the safety of all those nearby
- ▶ **Protecting Your Equipment:** Diamond Logic capabilities like an auto-locking and unlocking diff-lock, help mitigate human errors that can sometimes damage your equipment





PROACTIVE, PREDICTIVE TOOLS THAT DRIVE UPTIME AND LOWER TOTAL COST OF OWNERSHIP.

Some trucks take more abuse than others. And that's certainly the case with the International® HX Series. OnCommand® Connection can help make sure these hard-working assets are up to the task, thanks to:

- Advanced Remote Diagnostics
- Over-the-air (OTA) programming
- Configurable mobile app
- International® 360 Service Communications

5 YEARS

ADVANCED REMOTE DIAGNOSTICS

Monitor the health and status of your all-makes vehicles

Key Feature	Benefit
Fault alerts, Severity ratings, Most likely needed parts and service	Takes guesswork out of check engine lights so you know if it's a critical issue or if it can wait until the next scheduled service.
Comprehensive vehicle health reports, MPG, Fault history...And more	Delivers both high-level overview as well as detailed vehicle health data depending on your needs.
Interactive Fault Code Action Plans	Makes servicing vehicles faster and easier with detailed, step-by-step instructions on how to address vehicle faults.
GPS Location and Mapping	Tells you where vehicles are, where they have been, and how fast they've been driving. Shows nearby service stations, all-makes dealerships, tire centers, and more.
OTA Programming	Allows for increased uptime by setting programmable parameters and updating software calibrations remotely without taking the vehicle out of service.

ONCOMMAND® CONNECTION MOBILE APP

The power of OCC at your fingertips

Key Feature	Benefit
Fault code descriptions and severity	Instantly know what a check engine light means without bringing it to a service center.
Configurable home screen	Customize your app so you can see the details that are important to you.
Vehicle health reports with critical health details including "send via email" button	Instantly share vehicle health data with your dealer, home office, or send a copy to yourself.
Initiate service button	Give your dealer advanced notice before you arrive.

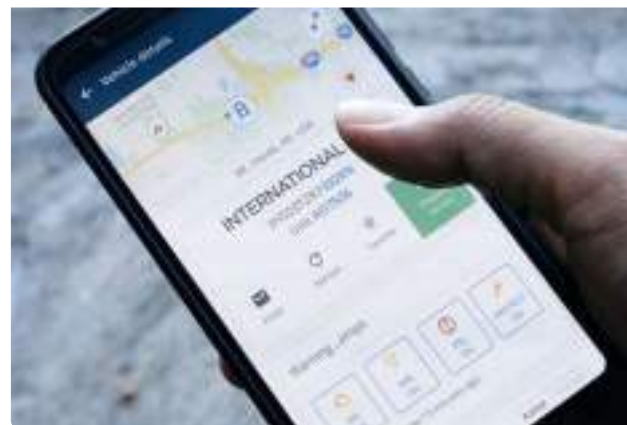

INTERNATIONAL® 360 SERVICE COMMUNICATIONS

Provides a seamless communication channel with the International service network.

- Streamlines communication, accelerates the repair process, and drives greater uptime
- The only OEM service communication tool that supports all-makes vehicles without per-VIN surcharges
- Integrates telematics, dealer parts inventory, and other vital information into one easy-to-use tool
- Centralizes vehicle health data, service history, and more



GATEWAY INTEGRATIONS — ONE SIZE DOES FIT ALL

Subscribe to select fleet management and compliance providers through our factory-installed telematics device. Whether you have one truck or 100, you'll get the data you need to help you run your business more efficiently.

- One factory-installed, warranty-covered device
- One high-quality source of vehicle data
- NO prewiring costs
- NO extra hardware costs
- NO aftermarket installation costs

Available Today



TECHNOLOGY BUILT TO BOOST YOUR UPTIME. AND BOTTOM LINE.





S13 INTEGRATED

Engine Type	Diesel, 4-Cycle
Configuration	Inline 6-Cylinder
Displacement	12.74L (777 cu. in.)
Bore & Stroke	5.12 in. x 6.30 in. (126 mm & 166 mm)
Compression Ratio	23:1
Aspiration	Fixed Geometry Turbocharger
Combustion System	1800 bar Common Rail
Engine Lubrication	47.5 Quarts (45L)
Total Engine Weight (Dry)	2,284 lbs. (1,036 kg)
Valves	4 Valves per Cylinder, Dual Overhead Camshaft
B10 Design Life	1,200,000 mi (1,931,000 km)

Industry-Leading Engine Warranty

Base Engine	2 years; unlimited miles, unlimited hours*
Base Major Component	5 years; 500,000 miles
Base Towing	2 years; unlimited miles, unlimited hours**
Optional Engine	Up to 6 years, 600,000 miles
Optional Major Component	Up to 7 years, 700,000 miles

* Fire & Rescue Applications: 60 Months/ 100,000 Miles/ Unlimited Hours
 **Towing for vehicles with engine failures



T14 Gear Ratios Available

Gear	Ratio	% Step	R Gear	Ratio
1	20.81	29%	R6	4.59
2	16.16	29%	R5	5.91
3	12.57	29%	R4	7.61
4	9.76	29%	R3	9.81
5	7.56	29%	R2	12.60
6	5.87	29%	R1	16.23
7	4.55	29%		
8	3.53	28%		
9	2.77	29%		
10	2.15	29%		
11	1.66	29%		
12	1.29	29%		
13	1.00	28%		
14	0.78	-		

Transmission, Clutch and Transmission Mounted PTO Base Warranty (includes Towing)

Less than 52K Rear Axles Rating	3 years; unlimited miles
Greater than 52K Rear Axles Rating	2 years; unlimited miles

S13 Integrated Power Curves

HP @ 1800 RPM	Torque [lb-ft] @ 900 RPM	Governed speed [RPM]
400	1450	2000
430	1550	2000
450	1750	2000
475	1750	2000
515	1850	2000



INTERNATIONAL® A26

Engine Type	Diesel, 4-Cycle
Configuration	Inline 6-Cylinder
Displacement	12.4L (758 cu. in.)
Bore & Stroke	4.96 in. & 6.54 in. (126 mm & 166 mm)
Compression Ratio	20.5:1
Aspiration	Variable Geometry Turbocharger
Combustion System	Direct Injection 2500 bar HPCR
Engine Lubrication	42 Quarts (40L)
Total Engine Weight (Dry)	2,314 lbs. (1,050 kg)
Valves	4 Valves per Cylinder, Dual Overhead Camshaft
B10 Design Life	1,200,000 mi (1,931,000 km)



HP Rating	Governed Speed RPM	Torque Rating (lb-ft @ RPM)
370	2100	1350 @ 1000
390	2100	1450 @ 1000
410	2100	1450 @ 1000
430	2100	1550 @ 1000
450	2100	1700 @ 1000
475	2100	1700 @ 1000
515	2100	1850 @ 1000

CUMMINS® X15

Engine Type	Diesel, 4-Cycle
Configuration	Inline 6-Cylinder
Displacement	14.9L (912 cu. in.)
Bore & Stroke	5.39 in. & 6.65 in. (137 mm & 169 mm)
Compression Ratio	18.9:1
Aspiration	Variable Geometry Turbocharger
Combustion System	Direct Injection XPI Fuel System
Engine Lubrication	56 Quarts (53L)
Total Engine Weight (Dry)	2,961 lbs. (1,343 kg)
Valves	4 Valves per Cylinder, Single Overhead Camshaft
B10 Design Life	1,000,000 mi (1,609,000 km)



Productivity Series

HP Rating	Governed Speed RPM	Torque Rating (lb-ft @ RPM)
430	2000	1650 @ 950
450	2000	1650 @ 950
450	2000	1750 @ 950
470	2000	1750 @ 950
500	2000	1850 @ 950
565	2100	1850 @ 1000
565	2000	1850 @ 1000
605	2000	1850 @ 1000
605	2000	2050 @ 1000
605	2100	1850 @ 1000

Performance Series

525	1900	1850 @ 1000
565	1900	1850 @ 1000
605	1900	2050 @ 1000



HX[®] SERIES SPECIFICATIONS

HX520

120" BBC Set-Forward Front Axle Truck or Tractor

Primary Vocations:

- Heavy Haul Tractor
- Construction Dump
- Logging
- Recovery

Key Features:

- Powerful 15L Cummins[®] X15 power up to 605 HP / 2,050 lb.-ft. torque
- Excellent bridge formula chassis
- Available 0.5", 3.5 million RBM single rail frame
- Available 150,000 lb. Tow Pin
- Available dual external air cleaners for HD filtration
- Front axles up to 20K and rear axles up to 58K
- BA = 29.9"



HX620

119" BBC Set-Back Front Axle Truck or Tractor

Primary Vocations:

- Heavy Haul Tractor
- Construction Dump
- Platform Stake/Crane

Key Features:

- International[®] S13 Integrated powertrain up to 515 HP / 1,850 lb.-ft. torque
- International[®] A26 engine up to 515 HP / 1,850 lb.-ft. torque
- Powerful 15L Cummins[®] X15 power up to 605 HP / 2,050 lb.-ft. torque
- Available 0.5", 3.5 million RBM single rail frame
- Available 150,000 lb. Tow Pin
- Front axles up to 22.8K
- Tandem rear axles up to 58K and Tridem to 69K
- Available dual external air cleaners for HD filtration
- BA = 50.2"



GVWR

- ▶ 52,000 - 91,800 lbs.

Models

- ▶ HX520 120" BBC, Set-Forward Front Axle Truck or Tractor
- ▶ HX620 119" BBC, Set-Back Front Axle Truck or Tractor

Axle Configurations

- ▶ 6x4
- ▶ 8x6
- ▶ 4x2 (upon request)

Cab Configurations

- ▶ Day Cab
- ▶ 56" Low and High Sleeper Cabs
- ▶ 73" High Sleeper Cab

Heat Treated Alloy Steel 120,000 PSI Frames

- ▶ Single Rail
 - 3/8": 10.25"x3.61"x0.375": 2,037,600 RBM
 - 3/8": 12.25"x3.380"x0.375": 2,521,200 RBM
 - 1/2": 12.5"x3.750"x0.5": 3,536,400 RBM
- ▶ Double Rail
 - 5/16"+ 5/16": 10.813"x3.893x0.625": 3,580,800 RBM
 - 3/8"+ 5/16": 13.030"x3.687"x0.6875": 4,854,000 RBM

S13 Integrated Powertrain/HX620

- ▶ International[®] S13
 - 400 - 515 HP
 - 1,450 - 1,850 lb.-ft.
- ▶ International[®] T14
 - 14-speed automated manual transmission
 - Transmission PTO
- ▶ Dual Stage Aftertreatment

Engines

- ▶ International[®] A26 12.4L
 - HX620
 - 370 - 515 HP
 - 1,250 - 1,850 lb.-ft.
- ▶ Cummins[®] X15 15L
 - HX520 / HX620
 - 430 - 605 HP
 - 1,650 - 2050 lb.-ft.

Transmissions

- ▶ International[®] T14: 14-speed automated manual
- ▶ Eaton Manual: 8LL (10), 9ALL (11), 13, 18-speed
- ▶ Eaton Automated Manual Endurant HD: 12-speed
- ▶ Eaton Automated Manual Endurant XD & XD Pro: 18-speed
- ▶ Allison Automatic: EVS, RDS, OFS Series

Clutch

- ▶ Standard: Hydraulic with Air Assist

Power Take Off

- ▶ Front Engine PTO (FEPTO) HX520
- ▶ Rear Engine PTO (REPTO) HX520, HX620

Front Axles

- ▶ HX620
 - Dana: 16,000 - 20,000 lbs.
 - Meritor: 12,000 - 22,800 lbs.
- ▶ HX520
 - Meritor: 12,000 - 20,000 lbs.

Front Suspensions

- ▶ HX520
 - Parabolic Taper-leaf: 12,000 - 20,000 lbs.
- ▶ HX620
 - Multi-leaf: 14,000 - 23,000 lbs.
 - Parabolic Taper-leaf: 13,200 - 22,000 lbs.
 - Slipper-Type: 20,000 - 24,000 lbs.

Rear Axles

- ▶ Tandem Rear Axles
 - Dana: 46,000 - 52,000 lbs.
 - Meritor: 40,000 - 58,000 lbs. Single and Double Reduction
- ▶ Tridem Rear Axles
 - Meritor: 50,000 - 69,000 lbs.

Rear Suspensions

- ▶ Spring Suspensions
 - Chalmers: 40,000 - 52,000 lbs.
 - Hendrickson HAULMAAX EX: 40,000 - 52,000 lbs
 - Hendrickson R, RT: 40,000 - 80,000 lbs.
- ▶ Air Suspensions
 - Hendrickson HAS: 40,000 - 46,000 lbs. 55" and 60" spacing
 - Hendrickson PRIMAAX EX: 46,000 - 52,000 lbs. 55", 60", 72" spacing
 - Hendrickson PAX Tridem: 69,000 lbs.



DRIVING PROFITABILITY

MORE TIME ON THE ROAD AND LESS TIME WAITING FOR REPAIRS

We understand making money means keeping your vehicles on the road. That's why uptime is so important to us. Dependable equipment spec'd for your needs or requirements is just the beginning. We also focus on fuel economy, preventive maintenance, optimized service intervals, and more to make sure the low cost of ownership of our vehicles helps keep you in the black.

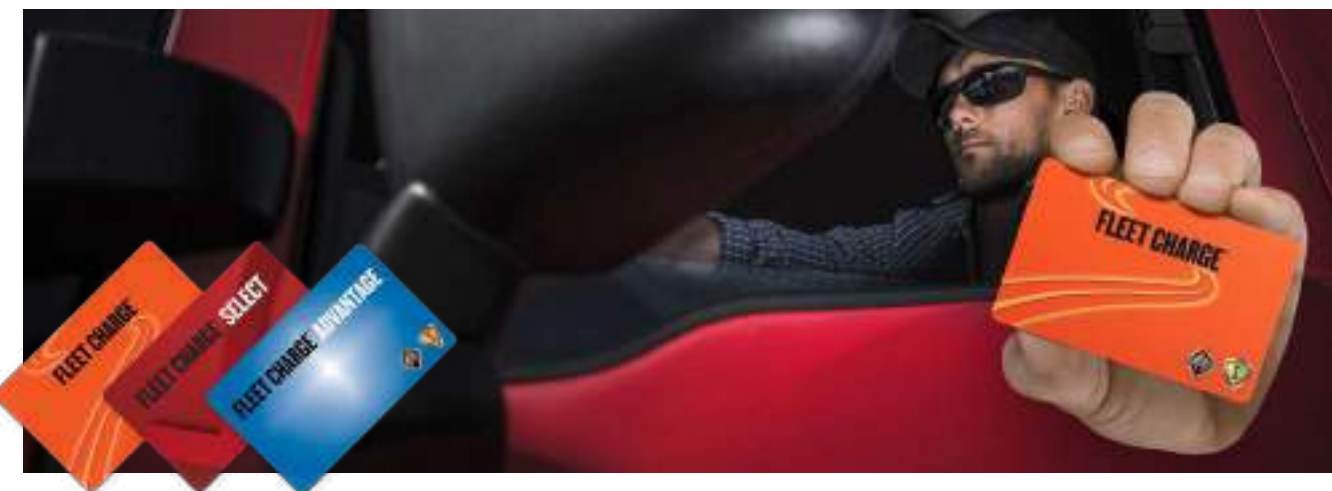

Maximum Uptime – Repair before Failure 

Prognostics that move unplanned repairs to planned. Optimizing maintenance using vehicle performance and predictive data.

Predictive Parts Stocking 

Dealer parts inventory management uses AI and telematics data to predict stocking needs. This ensures the best parts are on dealer shelves to support customers.

NAVISTAR FINANCIAL. UNLOCK YOUR POTENTIAL.

Navistar Financial offers flexible solutions to fit your financing needs, helping you secure the best products for your specific situation. Whether you're a loan customer or a lease customer the Navistar Financial team can provide you with the best option suited to your business.



For more information or to contact Navistar Financial, scan the QR code.

OVER 700 INTERNATIONAL® DEALER LOCATIONS + OVER 400 LOVE'S TRUCK CARE & SPEEDCO LOCATIONS =

OVER 1,100 TOTAL SERVICE LOCATIONS



TRUCK CARE

Our partnership with Love's Truck Care & Speedco adds 400+ additional locations for quick, conveniently located access to light mechanical and select warranty work*.

PARTS YOU NEED WHERE AND WHEN YOU NEED THEM

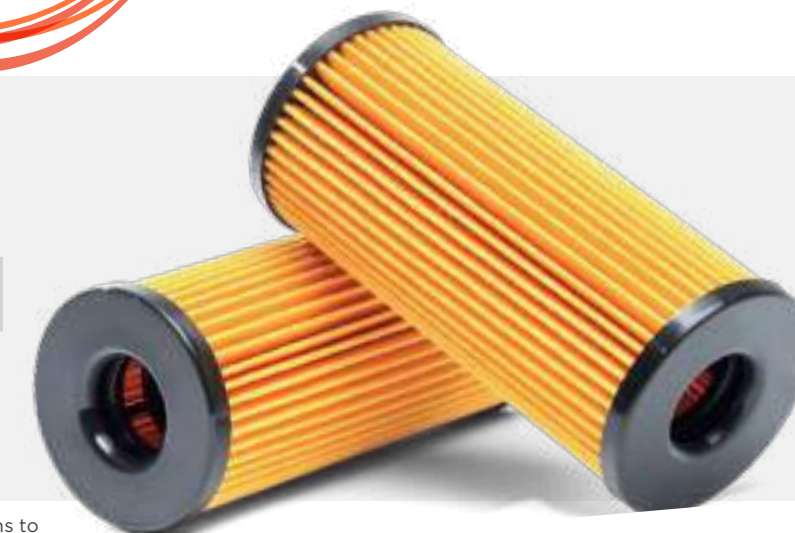

* Warranty-covered parts must be a certified International installed part for International Truck dealer service locations to honor warranty. Love's and Speedco locations in Texas and Louisiana cannot perform warranty services.



Note: The information and conclusions contained herein are believed to be correct at time of publication, but do not necessarily apply to similar vehicles with different specifications or with production dates after the production of this publication. Vehicles with different specifications or later dates of production may yield different results. Vehicle specifications are subject to change without notice. TAD20004 07/2023 ©2023 NAVISTAR Inc. All rights reserved. All marks are trademarks of their respective owners.